

POUR PLUS D'INFORMATIONS  
 FÜR MEHR INFORMATIONEN - PARA MAIS INFORMACOES - PARA MAS INFORMACION  
 VOOR MEER INFORMATIE - PER MAGGIEORI INFORMAZIONI - FOR MORE INFORMATIONS

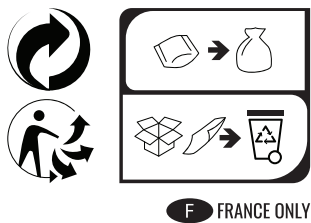

SLUGBAN.COM

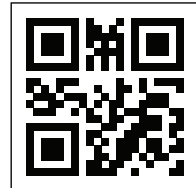

DISPOSITIF BREVETE - GEPATENTEERD PRODUCT - DISPOSITIVO  
 PATENTADO - DISPOSITIVO PATENTEADO - PATENTIERTES KONZEPT  
 DISPOSITIVO BREVETTATO - PATENTED DEVICE

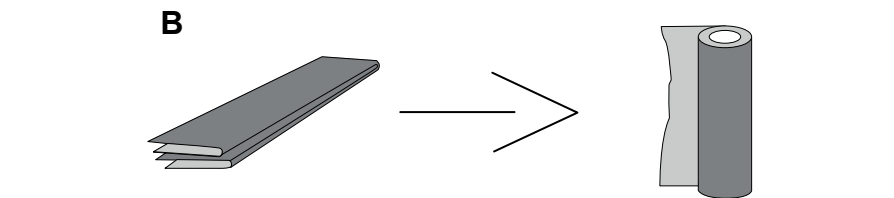
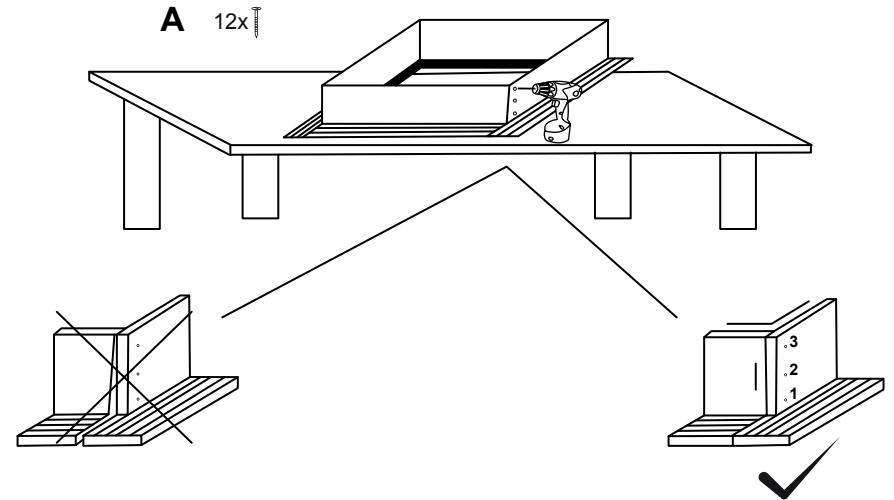
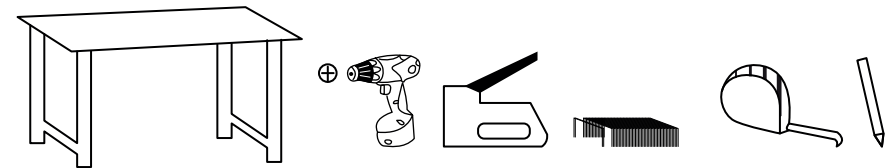
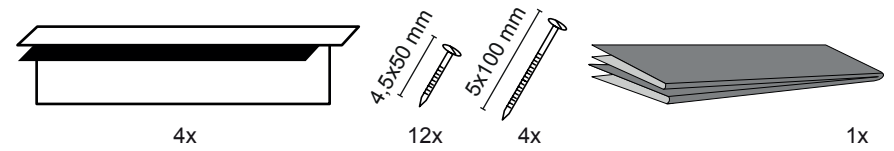

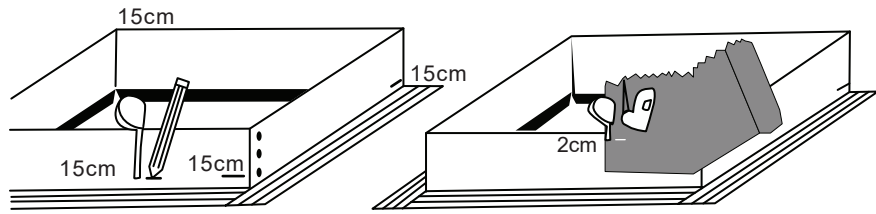

**C1**

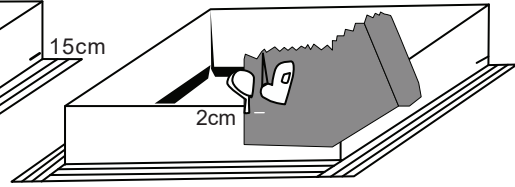

**C2**

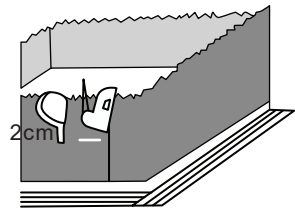

**C3**

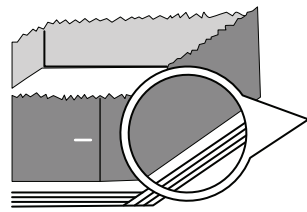

**C4**

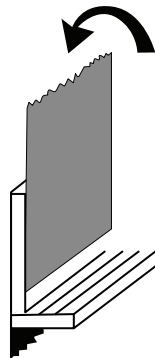
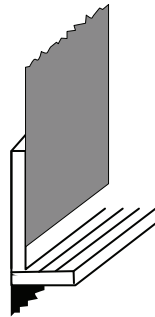

**C5**

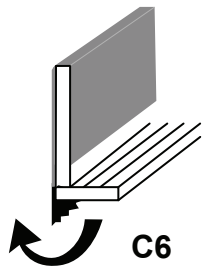

**C6**

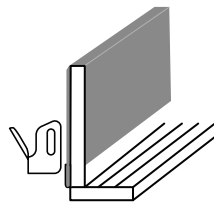

**C7**

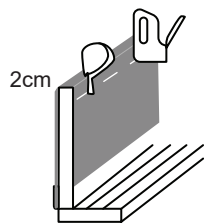

**C8**

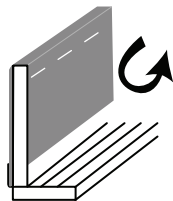

**C9**

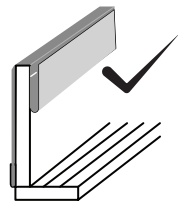

**C10**

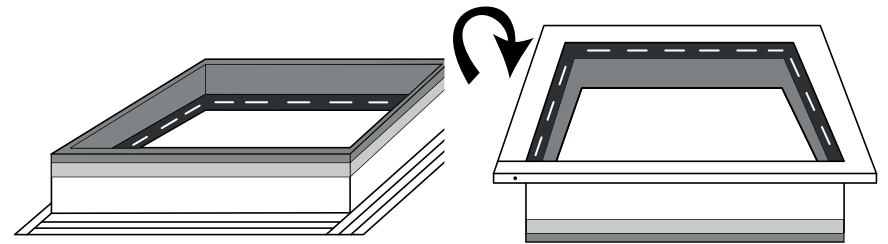

**C10**

**D**

**E**

4x

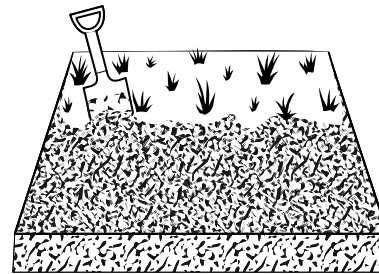
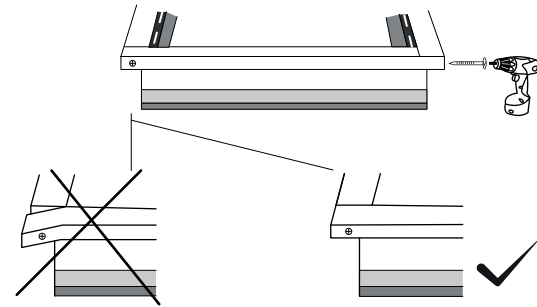

**F1**

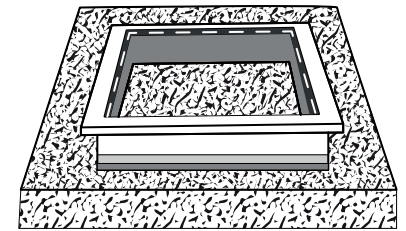

**F2**

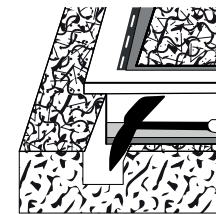

**G1**

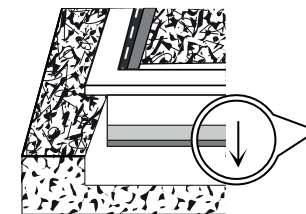

**G2**

